

Construction materials: **PP , PVDF+CF , PP+CF**

New pump line with a brand new designing that offers reinforced pumping potentials. The updated designing provides even bigger performance provided with economy.



II 2/2 G/D Ex h IIC T4 Gb/Db  
I M2 Ex h Mb

**5 YEARS  
LIMITED  
WARRANTY**

## Benefits

- Optimal performance
- Economical air consumption, ecological designing
- High efficiency for pressure/capacity
- Oil free operation
- No freezing
- New air valve designing, fully controlled air passing
- Easy disassembling and re-assembling
- New generation diaphragms with embodied inner-outer piston
- New generation PTFE diaphragms of embodied type for long-life operation (compound)
- Advanced quality Full capacity PTFE-A diaphragms for high chemical and mechanical applications
- Potential to be submersible (on request)
- Possibility to be used in dirty environments due to their closed designing
- Easy manifold reverse
- Automatic suction
- Twin manifold option (two suction and two delivery)
- Excellent performance and value for money
- Ideal for abrasive, viscous, and shear sensitive media

## Ruby 141 composition codes

Model	Pump Body	Center Section	Diaphragms	Ball Seats	Valve Ball	O-ring
Ruby 141 - 1 1/2"	P : PP V : PVDF+CF PC : PP+CF	P : PP PC : PP+CF	N : NBR Conductive E : EPDM Conductive F : VITON Conductive T : PTFE+back up (EPDM Conductive) Z : PTFE A+back up (EPDM Conductive)	V : PVDF P : PP N : NBR E : EPDM	T : PTFE N : NBR E : EPDM	T : PTFE F : VITON E : EPDM N : NBR

## Ruby Innovative oil free air valve

The heart of the Ruby pump is our innovative, new design air valve. In respect for New Era demands, to create and offer High Quality product, with high interest for the environment and it's protection, the Air Valve of the Ruby Diaphragm Pumps has been created to offer:

- ✓ Oil free operation
- ✓ Low need for maintenance
- ✓ Not affected by minor contamination of compressed air
- ✓ Significant energy saving
- ✓ Non freezing operation
- ✓ External environment operation
- ✓ No dead centre
- ✓ Long life
- ✓ Reliability

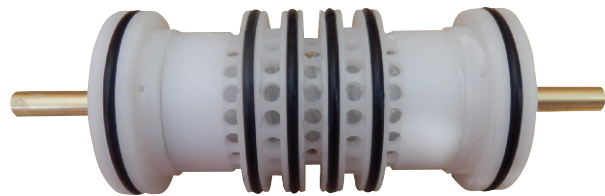

## Advance unified diaphragms featuring:

- ✓ Easy installation and maintenance
- ✓ Excellent service life
- ✓ Inventory cost reduction
- ✓ Improved performance
- ✓ Greater displacement per cycle
- ✓ No center hole, elimination of potential leak paths.
- ✓ There is no need for the main axis to be insured
- ✓ They can be screwed and unscrewed without the use of tools



### Advance Unified Diaphragm offers:

**The prominences decrease** the stretching of the PTFE during the regression and prevent it from cracking.

**Innovative conical shape** ideal for optimal performance and life, low pressure requirements for start-up, ideal suction

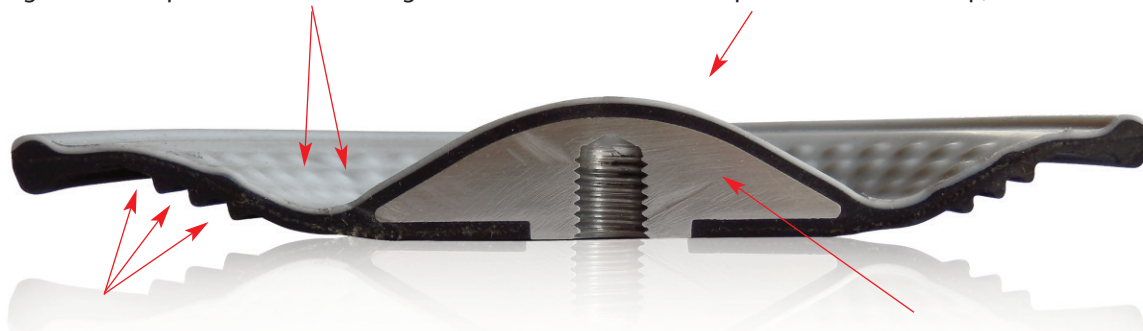

**Innovative diaphragm support side,** offers flexibility, long life and protects from cavitation

**Special internal plate** supports your diaphragm in every movement

### Technical data

ATEX Certificate	CE  STANDARD : II 3/3 G/D Ex h IIB T4 Gc/Dc CONDUCT : II 2/2 G/D Ex h IIC T4 Gb/Db – I M2 Ex h Mb
Construction materials	PP, PVDF+CF, PP+CF
Diaphragms	NBR Conductive EPDM Conductive Compound PTFE+Back up EPDM Conductive Compound PTFE A+Back up EPDM Conductive Viton conductive
Intake/delivery connections	Flange DN 40/ANSI 40
Air connection	1/2 "
* Max self-priming capacity	4 m
* Max. flow rate	380 l/min
Max. solid size (diameter)	5mm
Max head	80 m
Max air supply	8Bar
Max operating Temperature	PP: 60°C PP+CF: 60°C PVDF: 95°C
Weight PP	14 kg
Weight PVDF	22 kg

\* The curves and performance values refer to pumps with submerged suction and a free delivery outlet with water at 20°C, and vary according to the construction material.

## Performance

### RUBY 141 - FULL CAPACITY PTFE - A FITTED

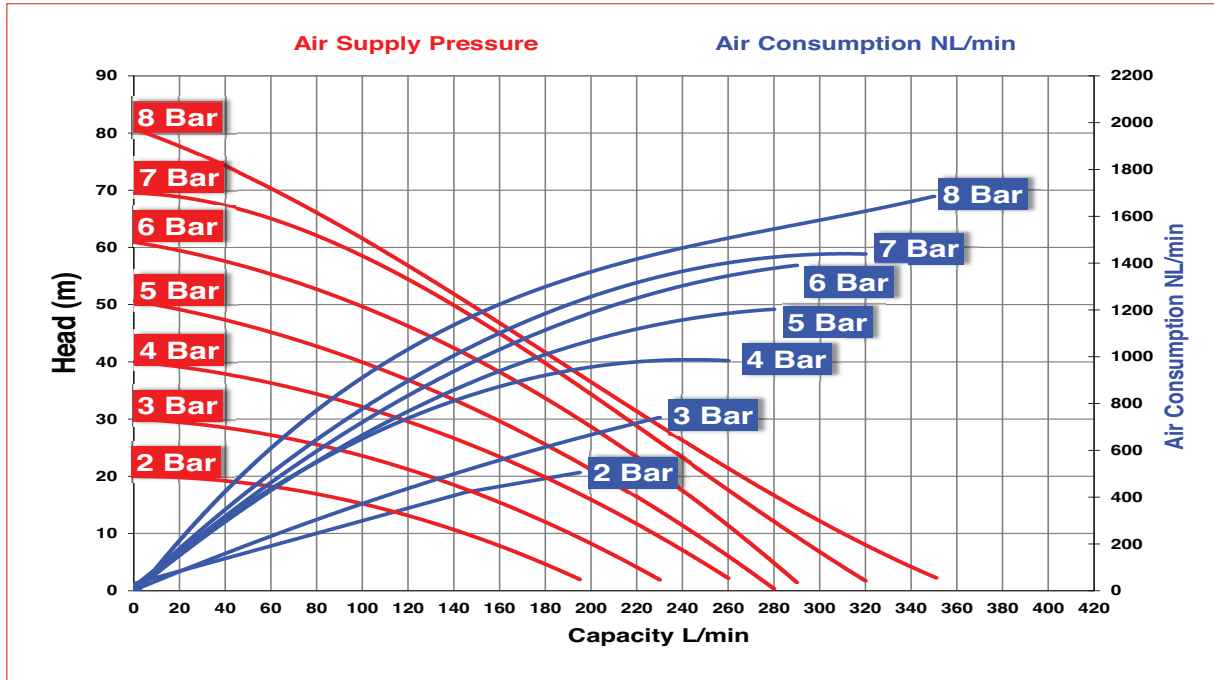

### RUBY 141 - RUBBER FITTED

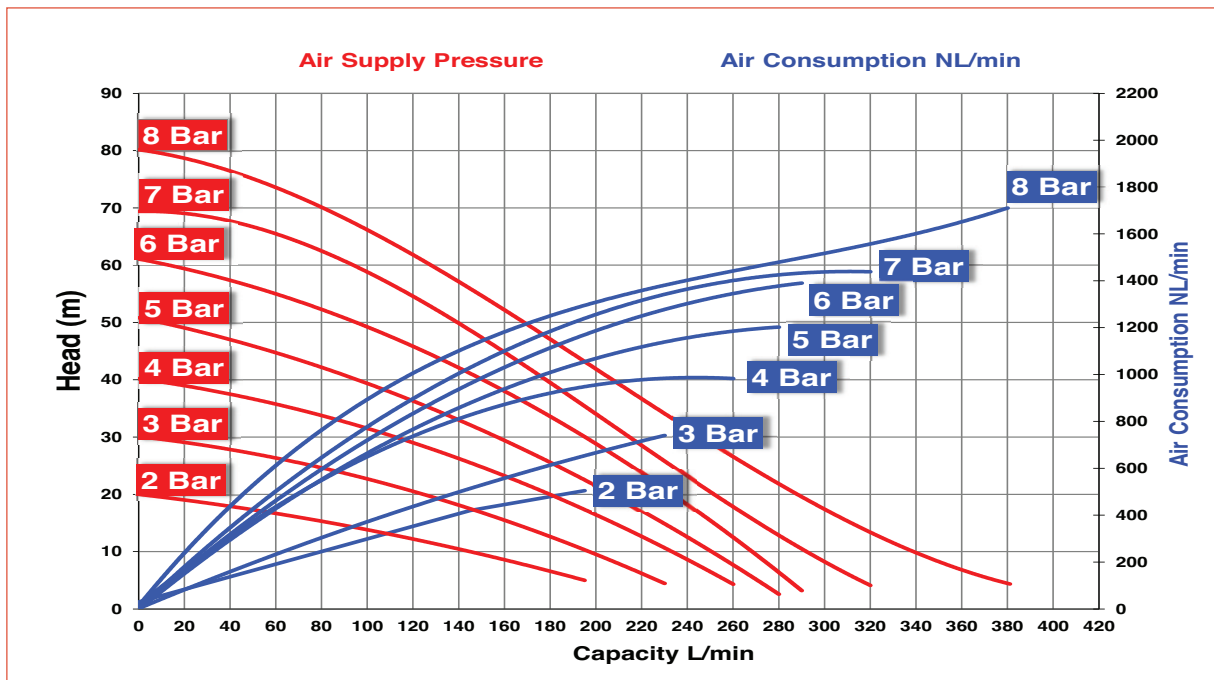

## Performance

### RUBY 141 - PTFE FITTED

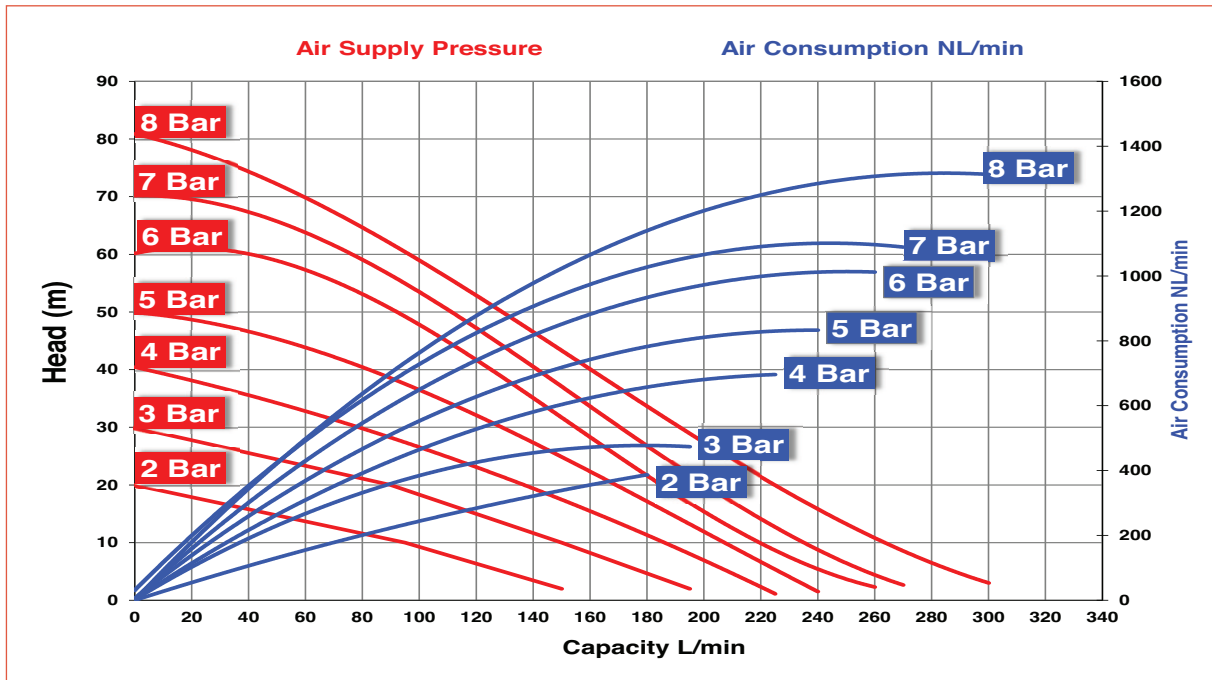

## Dimensions

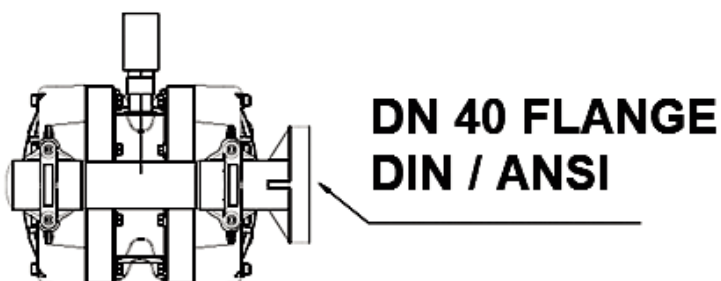
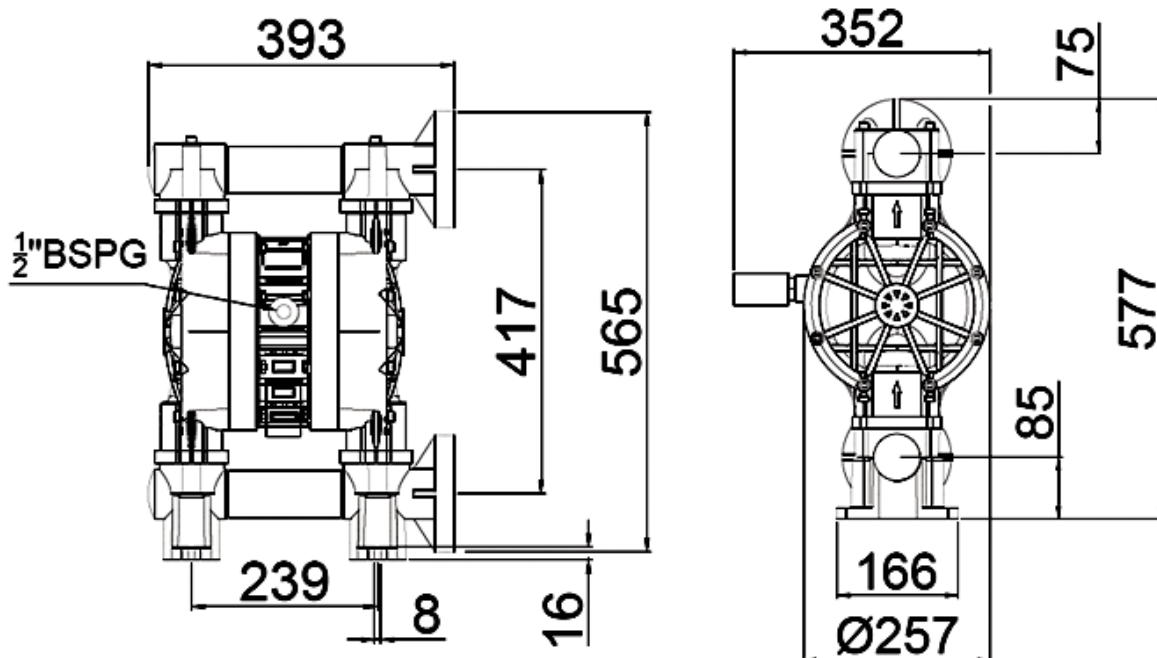

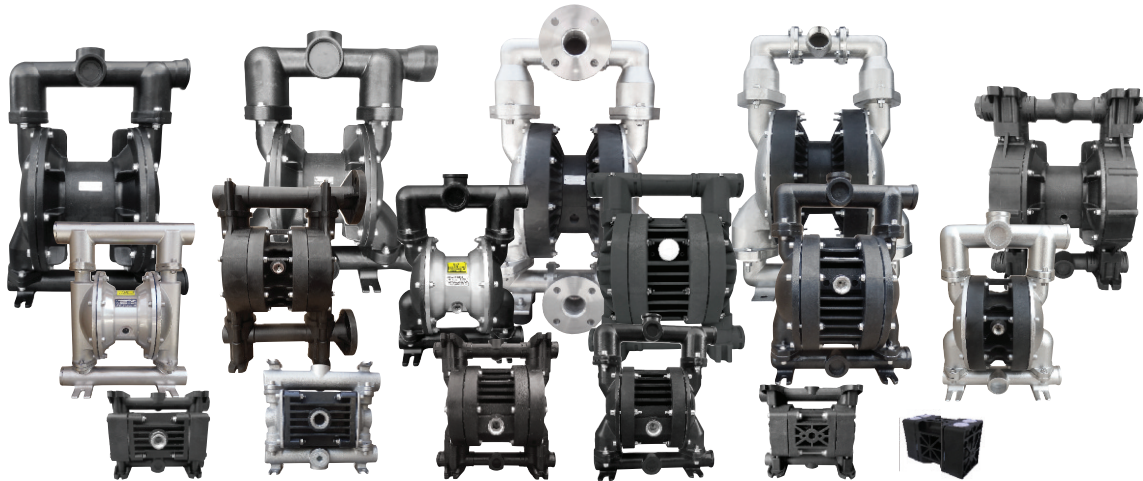

*We Make The Difference*



#### **Production Plant - Greece**

Inofita Industrial area  
59th km Nat.Road Athens- Lamia  
GR 320 11 Inofita Viotia, Greece  
Tel +30 215 215 9520 , +30 215 215 9580  
Email: [Sales@alphadynamic.eu](mailto:Sales@alphadynamic.eu)  
[www.alphadynamic.eu](http://www.alphadynamic.eu)

#### **Sales Office – England**

Rockleigh House, 37 Burton Road  
Ashby de la Zouch , Leicestershire  
LE65 2LF - United Kingdom (UK)  
Registered in ENGLAND & WALES  
Registration number 09706219  
Tel +44 1213 680 324 , +44 1213 680472  
Email: [Sales@alphadynamic.eu](mailto:Sales@alphadynamic.eu)  
[www.alphadynamic.eu](http://www.alphadynamic.eu)